

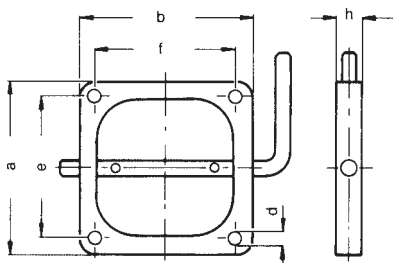

ACCESSORIES

Throttle valve

for fitting on the blower discharge side



Blower Type	a	b	d	e	f	h	code no.
E 02 SP	70	70	7	54	54	23	000034
D 03, E 03	72	72	7	56	56	23	000035
D 04, E 04 2D 04	76	76	7	64	64	23	000095
D 045, E 045 2D 045	112	98	7	95	80	20	008420
D 05, E 05 2D 05	112	112	9	96	96	23	000036
D 052, E 052 2D 052	130	130	7	105	115	23	000264
D 060, E 060 2D 060	140	140	9	115	115	23	001350
D 064, E 064 2D 064	150	130	9	130	110	23	000093
D 066, E 066 2D 066	155	155	9	130	130	23	001129
D 07, D 072 2D 07	190	210	11	160	180	23	000094
D 08, D 082 2D 08	190	190	11	165	165	23	000106
D 09, D 092	220	220	11	196	196	23	000490

Discharge connector

for tube connection

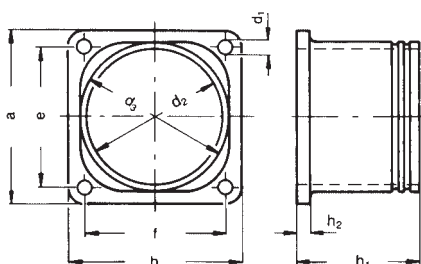

Blower Type	a	b	d ₁	d ₂	d ₃	e	f	h ₁	h ₂	code no.
E 02 SP	70	70	7	46	54	54	54	70	5	000043
D 03, E 03	72	72	7	52	60	56	56	70	5	000044
D 04, E 04 2D 04	80	80	7	60	70	64	64	70	6	000045
D 045, E 045 2D 045	98	112	7	76	80	80	95	85	2	009594
D 05, E 05 2D 05	112	112	9	86	96	96	96	100	8	000046
D 052, E 052 2D 052	130	130	7	92	99	105	115	100	8	000273
D 060, E 060 2D 060	140	140	9	110	120	115	115	100	10	001351
D 064, E 064 2D 064	150	130	9	104	114	130	110	100	12	000123
D 066, E 066 2D 066	155	155	9	125	135	130	130	100	12	001144
D 07, D072 2D 07	190	210	11	150	160	160	180	120	12	000048
D 08, D 082 2D 08	190	190	11	155	165	165	165	100	12	000124
D 09, D 092	220	220	11	170	180	196	196	140	15	000489

Dimension in mm – subject to modifications

ACCESSORIES



Intake connector

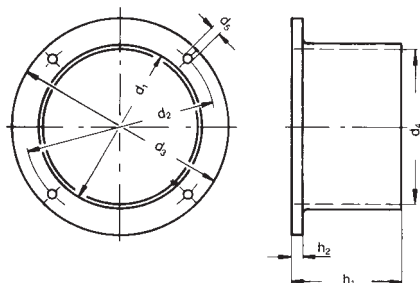

Blower Type	d ₁	d ₂	d ₃	d ₄	d ₅	h ₁	h ₂	code no.
E 02 SP	on demand							
D 03, E 03	100	120	131	90,5	4 x 5,8	100	6	000713
D 04, E 04 2D 04	120	140	151	110,5	4 x 5,8	100	6	000714
D 045, E 045 2D 045	120	144	155	116	4x5	100	2	009595
D 05, E 05 2D 05	130	147	160	119,5	4 x 5,8	100	6	000715
D 052, E 052 2D 052	151	171	180	140	4 x 5,8	100	6	000254
D 060, E 060 2D 060	150	176	188	140	4 x 5,8	120	6	000716
D 064, E 064 2D 064	160	198	210	149,5	4 x 5,8	140	6	000717
D 066, E 066 2D 066, D 07, D 072, 2D 07	190	238	252	179	4 x 7	160	10	000718
D 08, D 082 2D 08	220	256	272	208	4 x 7	160	10	000719
D 09, D 092	250	290	310	234	8 x 7	180	10	000488

Dimension in mm – subject to modifications



ACCESSORIES

Finefilter intake side

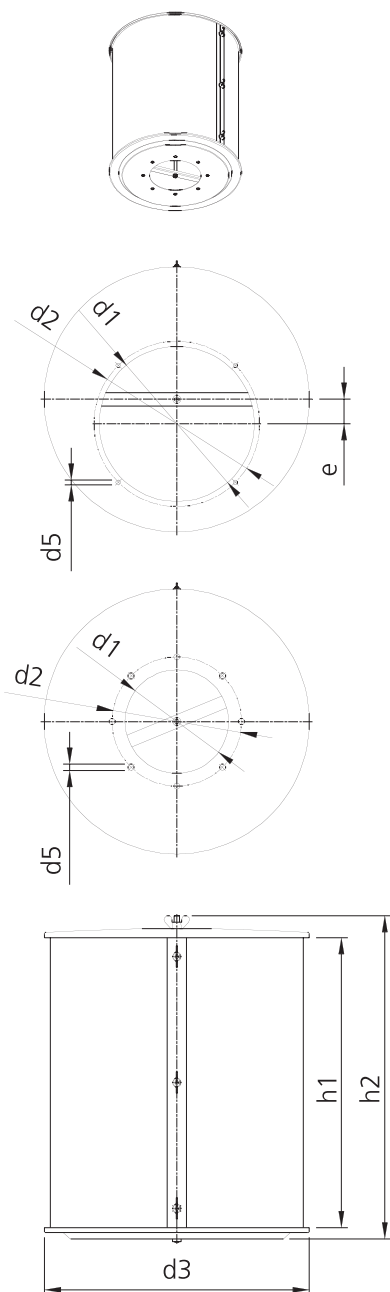

Layout and dimensions of Elektror finefilters are adapted to the maximum flow volume of the respective blowers and have a very small pressure loss therefore.

The filter surface has been selected for an air resistance of 50 Pa at an air flow velocity of 1,5 m/s. The inserted filter tissue of synthetic fibres provides a high filtration efficiency and corresponds to filter class G4 (former: EU 4) according to DIN EN 779.

Dirty filters may be cleaned with compressed air or by washing with a light soap lye. All steel parts are zinc-galvanised to provide high corrosion protection.

Caution

Clogged and dirty filters reduce the blower performance significantly. Cleaning of the filters in regular intervals is essential.

The permeability of the filters has to be guaranteed.

Blower Type	d ₁	d ₂	d ₃	d ₅	e	h ₁	h ₂	code no.
E 02 SP	95	105	148	4 X 5	-	153	111	009098
D 03, E 03	95	120	148	4 X 6	-	153	111	009098
D 04, E 04 2D 04	120	140	210	4 X 6	-	153	111	009116
D 045, E 045 2D 045	130	144	210	4 x 5	25	193	151	009097
D 05, E 05 2D 05	120	147	210	4 X 6	-	258	216	009117
D 05, E 05 2D 05 shortened execution	120	147	210	4 X 6	-	193	151	009306
D 052, E 052 2D 052	130	171	210	4 X 6	10	258	216	009118
D 060, E 060 2D 060	130	176	260	4 X 5,5	-	293	241	009119
D 064, E 064 2D 064	150	198	260	4 X 6	-	397	345	009120
D 066, E 066 2D 066	222	238	315	4 X 7	24	501	449	0091222
D 07, D 072 2D 07	222	238	315	4 X 7	24	501	449	009122
D 08, D 082 2D 08	240	256	410	4 X 7	38	501	449	009123
D 08, D 082 2D 08 shortened execution	240	256	410	4 X 7	38	267	215	009096
D 09, D 092	270	290	410	8 X 7	-	709	657	009307

Dimension in mm – subject to modifications

ACCESSORIES



Spare filter tissue for finefilter

Blower Type	Dimensions	code no.
E 02 SP	15 x 120 x 425	008636
D 03, E 03	15 x 120 x 425	008636
D 04, E 04 2D 04	15 x 120 x 620	008598
D 045, E 045 2D 045	15 x 160 x 620	008599
D 05, E 05 2D 05	15 x 225 x 620	008600
D 05, E 05 2D 05 shortened execution	15 x 160 x 620	008599
D 052, E 052 2D 052	15 x 225 x 620	008600
D 060, E 060 2D 060	15 x 250 x 750	008604
D 064, E 064 2D 064	15 x 355 x 750	008605
D 066, E 066 2D 066, D 07 D 072, 2D 07	15 x 460 x 960	008607
D 08, D 082 2D 08	15 x 460 x 1180	008612
D 08, E 08 2D 08 shortened execution	15 x 225 x 1220	008609
D 09, D 092	15 x 665 x 1220	008613

Dimension in mm – subject to modifications



ACCESSORIES FOR COMPACT BLOWERS

Finefilter

intake side

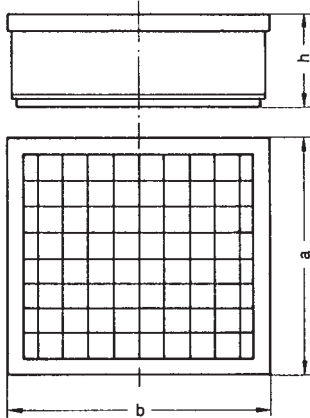

Blower Type	d_2	d_4	h_2	code no.
DK 1/2 EK 1/2	235	259	80	000430
DK 2/2 DK 3/2 clockwise rotation	324	379	113	000638
DK 2/2 DK 3/2 counter-clockwise rotation	324	379	113	000075

Spare filter tissue

for finefilter

Blower Type	Dimensions	code no.
DK 1/2 EK 1/2	15 x 225 x 250	000660
DK 2/2 DK 3/2	15 x 320 x 375	000608

Step switch 2 steps

without housing, enclosure IP 00,
for three and single phase

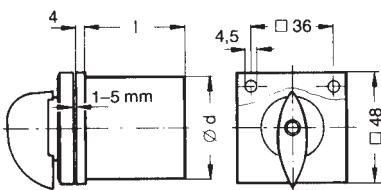

Blower Type	Three phase a.c.		code no.
	d	l	
D 03 RS – D 072 RS	44	80	000622
D 082 RS, D 092 RS	50	100	000685

Step switch 2 steps

with housing, enclosure IP 54
for three and single phase a.c.

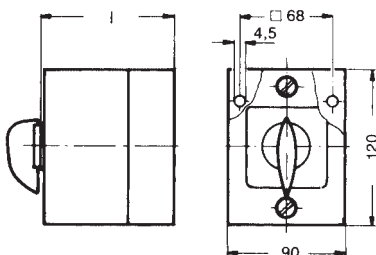

Blower Type	Three phase a.c.		code no.
	l		
D 03 RS – D 072 RS	103		000711
D 082 RS, D 092 RS	103		000712

Dimension in mm – subject to modifications